

Art. Nr. 2825150

1/6



G 1000

Art. Nr. 2825150

Groundplan - Grundplan - Plan de masse - Planimetria -
Plattegrond - Põhiplaan

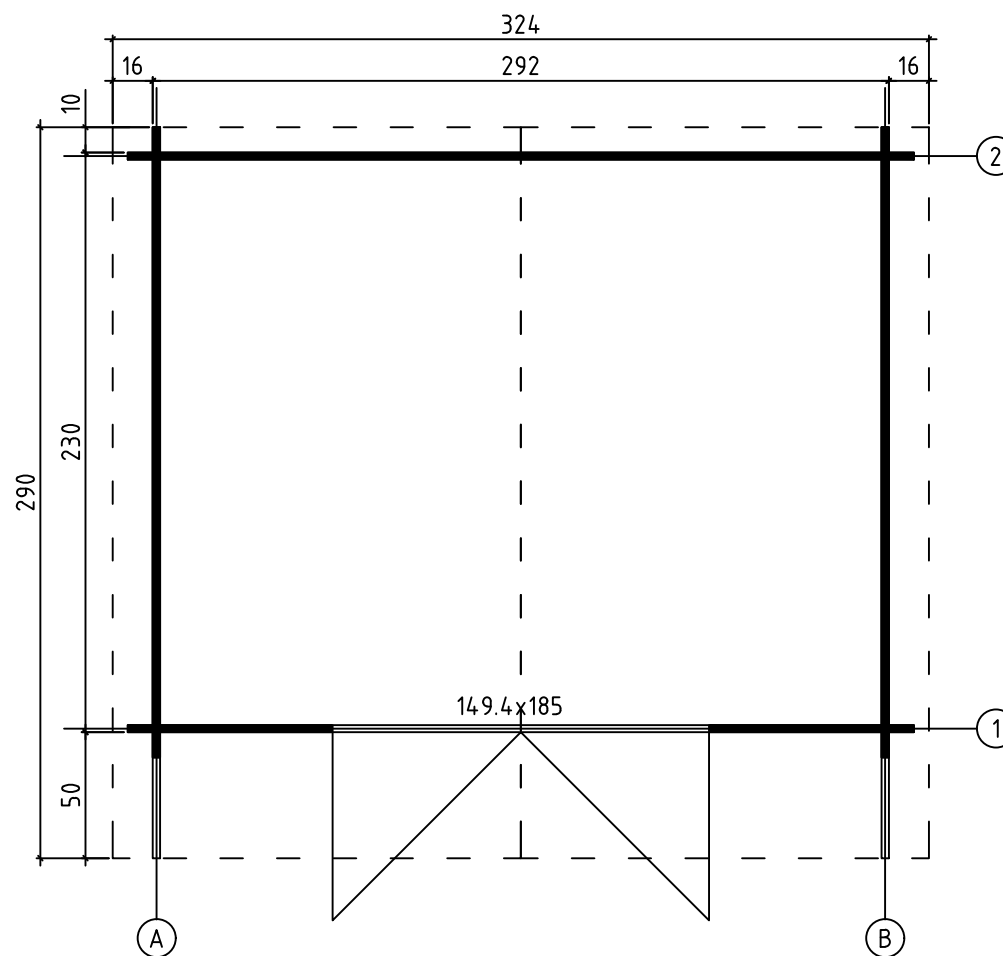



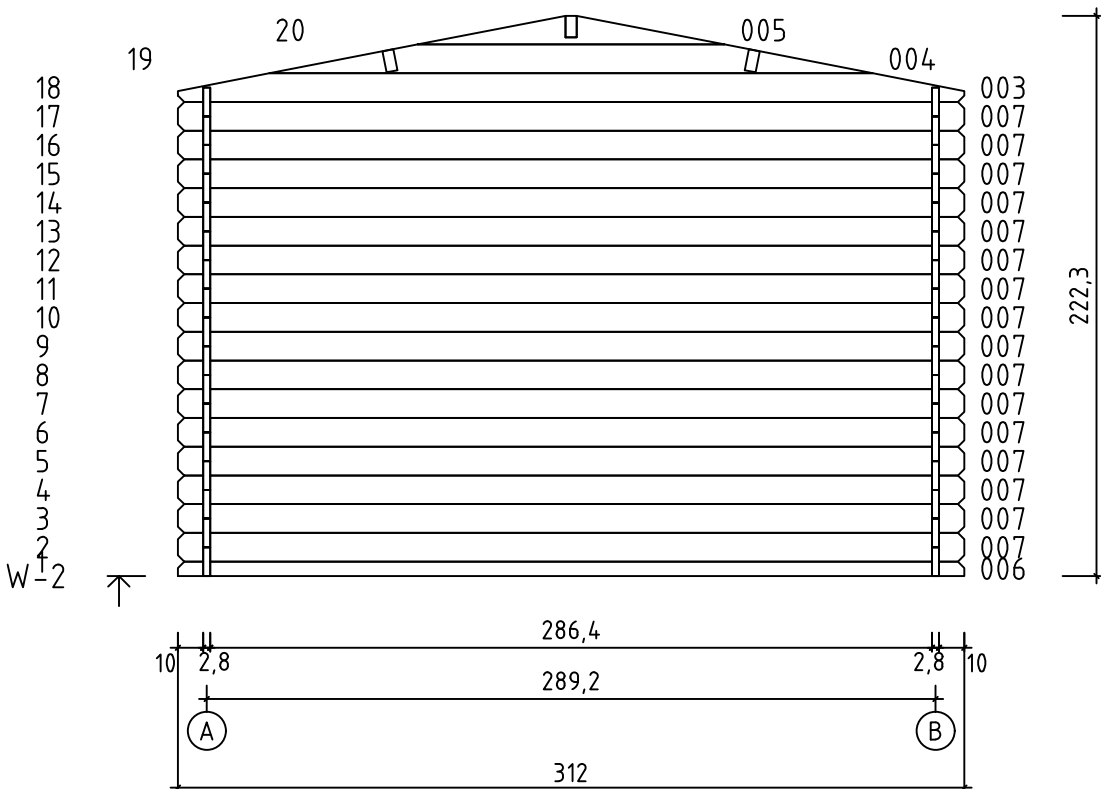
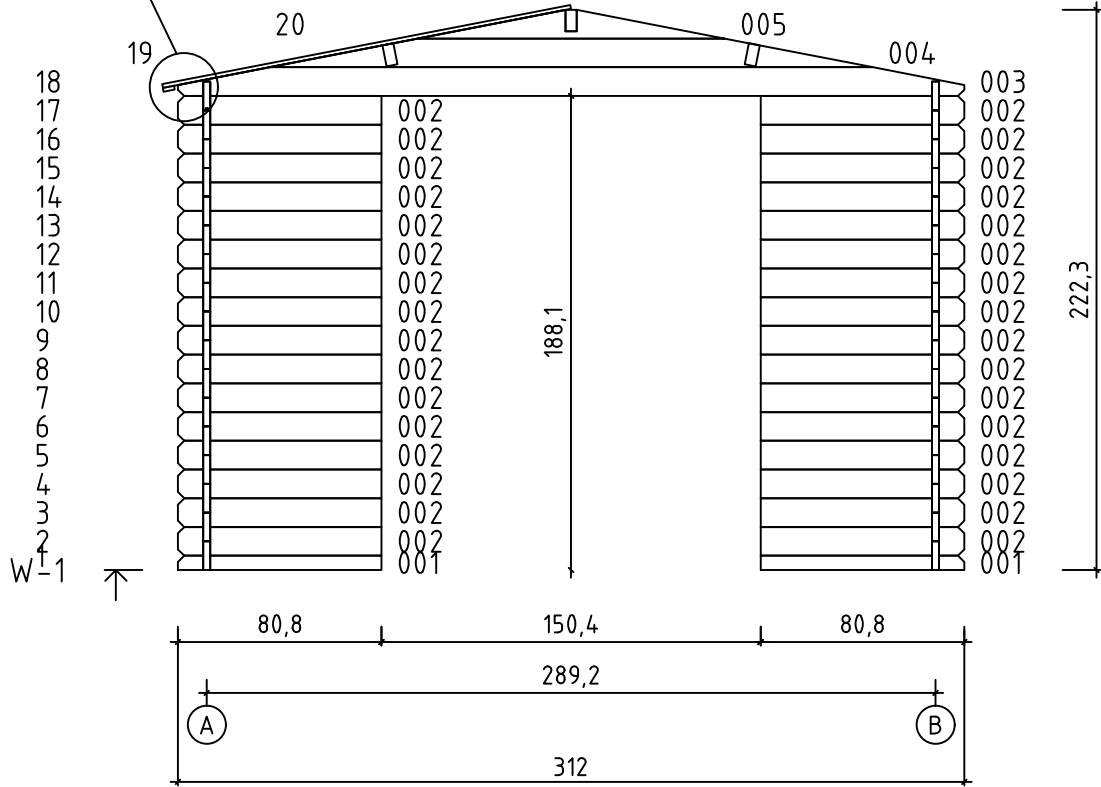
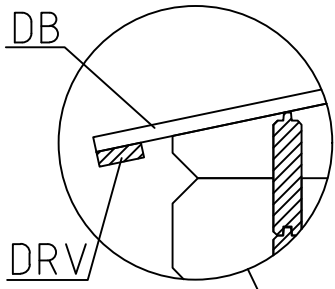



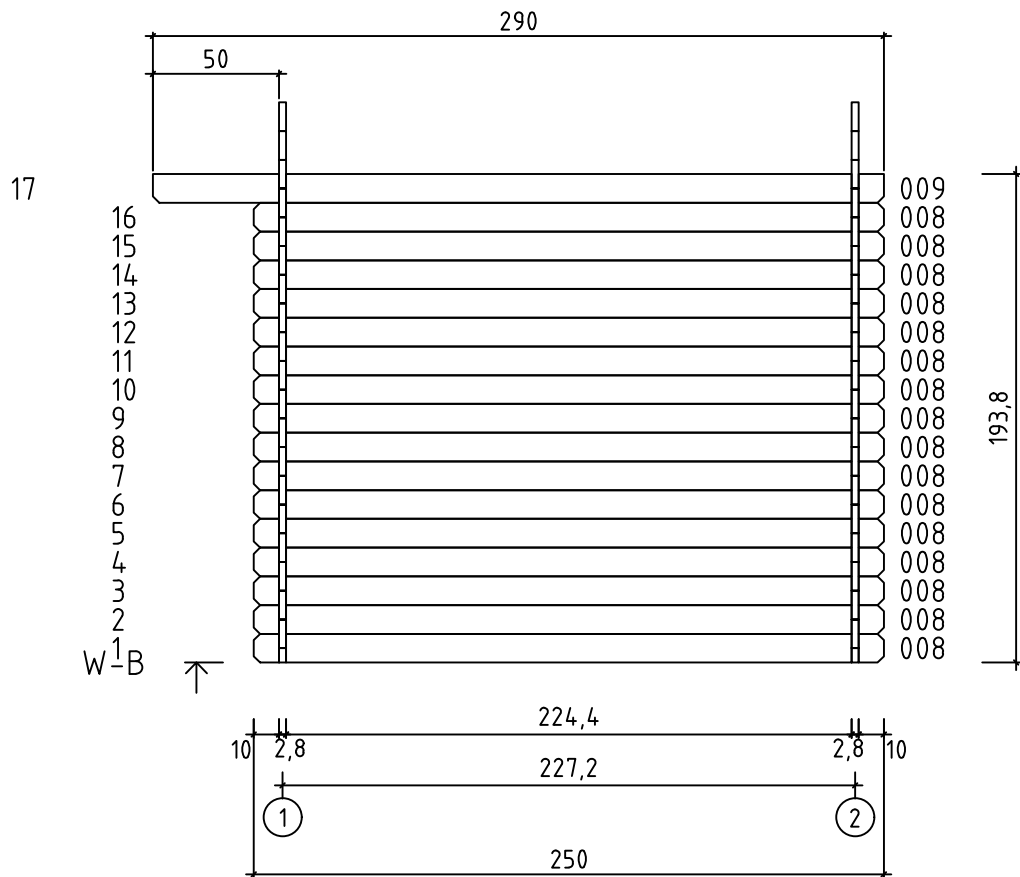
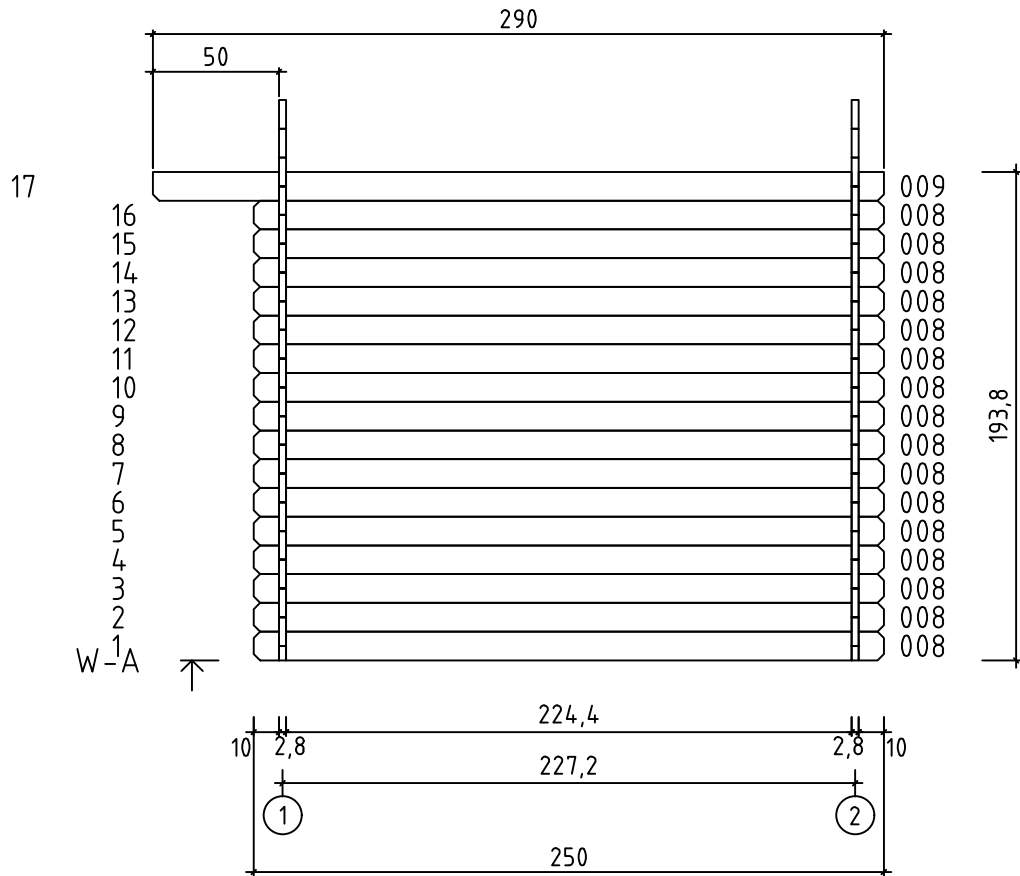

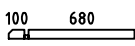
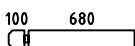
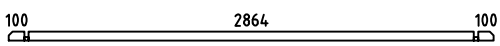
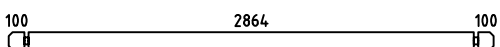
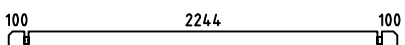
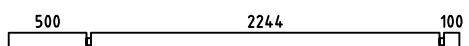

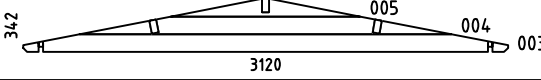
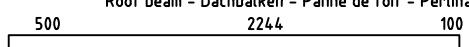
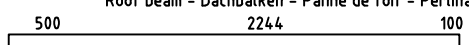

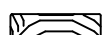

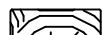
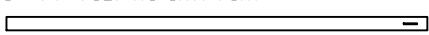
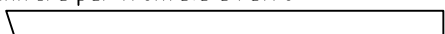

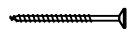
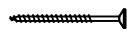
Art. Nr. 2825150

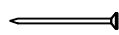

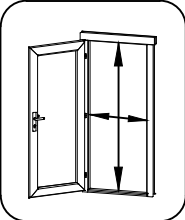
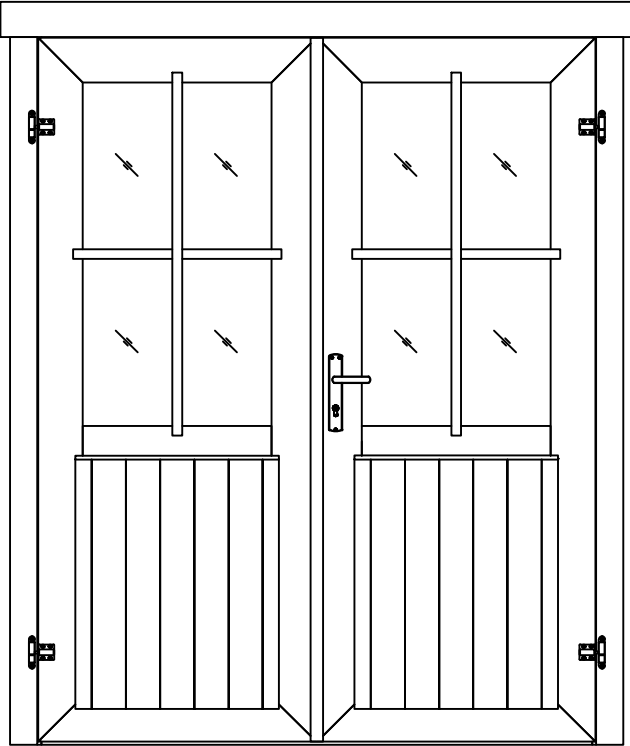
Art. Nr. 2825150

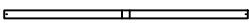
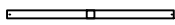

| Pos | 26.03.2018 Piece list - Stückliste - Liste des pièces - Elementi - Stuklijst - Tükítabel Art. Nr. 2825150 | 5/6 | Q | P (mm) | L (mm) |
|-------|----------------------------------------------------------------------------------------------------------------------------------------------------------------------------------------------------------------------------------------------------------------------------------------------------------------|-----|-----|-----------|-----------|
| 001 |  | | 2 | 28x57 | 808 |
| 002 |  | | 32 | 28x114 | 808 |
| 006 |  | | 1 | 28x57 | 3120 |
| 007 |  | | 16 | 28x114 | 3120 |
| 008 |  | | 32 | 28x114 | 2500 |
| 009 |  | | 2 | 28x114 | 2900 |
| W1-1 |  | | 1 | | |
| W2-1 |  | | 1 | | |
| A-PR1 | Roof beam - Dachbalken - Panne de toit - Perlina del tetto - Gordingen / dakbalk - Pärlin  | | 2 | 44x95 | 2900 |
| A-PR2 | Roof beam - Dachbalken - Panne de toit - Perlina del tetto - Gordingen / dakbalk - Pärlin  | | 1 | 44x95 | 2900 |
| | Roof boards - Dachbretter - Voliges - Perlina per tetto - Dakhout - Katuselaud  | | 66 | 90x15 | 1650 |
| | Roofing felt fillet - Dachpappenleiste - Baguette de fixation du feutre bitumeux - Asse per fissaggio guaina bituminosa - Afdekljst asfaltpapier - Katusepapiilist  | | 4 | 15x45 | 1700 |
| DPP-1 | Roofing felt (strip) - Dachpappe (bahnen) - Feutre bitumeux (bande) - Cartone catramato - Asfaltpapier (baan) - Katusepapp  | | 4 | | 3000 |
| DRV-1 | Roof edge reinforcement - Dachrandverstärkung - Corniere de renfort de bord de toit - Rinforzo x tetto - Dakrand versterking - Räästatugevdus  | | 2 | 15x45 | 2900 |
| KFS-1 | Storm protection - Sturmleiste - Latte anti-tempete - Protezione anti vento - Stormverankering / beveiliging - Tormikinnitusliist  | | 4 | 22x45 | 2050 |
| | Gable moulding - Giebelleiste - Planche de rive - Finitura per frontale e retro del tetto - Gevellijst - Viitulaud  | | 4 | 15x120 | 1700 |
| HS8 | Screw for gable segment - Schrauben für deckblatt - Vis pour fixation losange de finition - Viti x frontali tetto - Schroef voor gevelpunt segment - Kruvi rombile  | | 4 | 3.5x35 | |
| HS9 | Screw for gable moulding - Schrauben für giebelleiste - Vis pour fixation planche de rive - Vite per fissare finiture davanti e dietro del tetto - Schroef voor gevellijst - Kruvi viitulauale  | | 24 | 3.5x50 | |
| HS4 | Screw for roof edge reinforcement - Schrauben für dachrandverstärkung - Vis pour fixation corniere renfort de bord de toit - Viti x rinforzo bordo tetto - Schroef voor dakrand versterking - Kruvi räästatugevdusele  | | 14 | 3x30 | |
| HS18 | Screw for roof beams - Schrauben für dachbalken - Vis pour fixation pannes de toit - Viti per perline del tetto - Schroef voor gordingen / dakbalken - Kruvi pärlinitele  | | 10 | 5x120 | |
| SH28 | Hammer block - Schlagholz - Calle de frappe - Blocco di legno da usare come cuscinetto quando si usa il martello - Slagklos - Löögiklots  | | 1 | | |
| SFS | Nut for storm protection - Schraubenmutter für sturmleiste - Ecrou pour latte anti-tempete - Dado x asta protezione vento - Moer voor stormverankering - Mutter tormikinnitusliistule  | | 8 | D6 | |
| NF4 | Zn nail for roof - Zn nagel für dachbretter - Pointe pour fixation voliges de toit - Chiodi x perline tetto - Spijker(nagel) voor dakhout - Nael katuselauale  | | 212 | 2x50 | |

| Pos | 18.12.2017 | Piece list - Stückliste - Liste des pièces - Elementi - Stuklijst - Tükítabel 14.94x1850 TUK.2.044.SVP.MX28 SGA+28 | 1/2 | Q | P (mm) | L (mm) |
|----------------------------------------------------------------------------------------------------------|----------------------------------------------------------------------------------------------------------------------------------------------|-----------------------------------------------------------------------------------------------------------------------|---------------------------------------------------------------------------------------|---|-----------------------------------------------------------------------------------------------------|-----------|
| Glass size - Glasgröße - Taille de la vitre - Misura del vetro - Glas afmeting - Klaasi mõõt: 502x900 mm | | | | |  1418x1794 mm | |
|  | | | | | | |
| 1 | Upper door jamb - Türrahmen oben - Cadre de porte supérieur - Telaio superiore della porta - Bovendorpel - Ukse ülemine leng | |  | 1 | 66x100 | 1438 |
| 2 | Left door jamb - Türrahmen links - Cadre de porte gauche - Telaio montante sinistro della porta - Linkerstijl deurframe - Ukse vasak leng | |  | 1 | 66x80 | 1850 |
| 3 | Right door jamb - Türrahmen rechts - Cadre de porte droit - Telaio montante destro della porta - Rechterstijl deurframe - Ukse parem leng | |  | 1 | 66x80 | 1850 |
| 4 | Doorstep - Swelle - Barre de seuil - Soglia della porta - Deurdorpel - Lävepakk | |  | 1 | 18x18 | 1418 |
| 5 | Connection strip - Deckleiste - Baguette de battement - Profilo verticale della porta - Stulplijst - kokkuvaltsiliist | |  | 1 | 13x32 | 1812 |
| 6 | Georgian bars - Sprossen - Croisillons - La griglia georgiana - Raamverdeling - Petteliistud | |  | 2 | 15x25 | 934 |
| 7 | Georgian bars - Sprossen - Croisillons - La griglia georgiana - Raamverdeling - Petteliistud | |  | 2 | 15x25 | 536 |

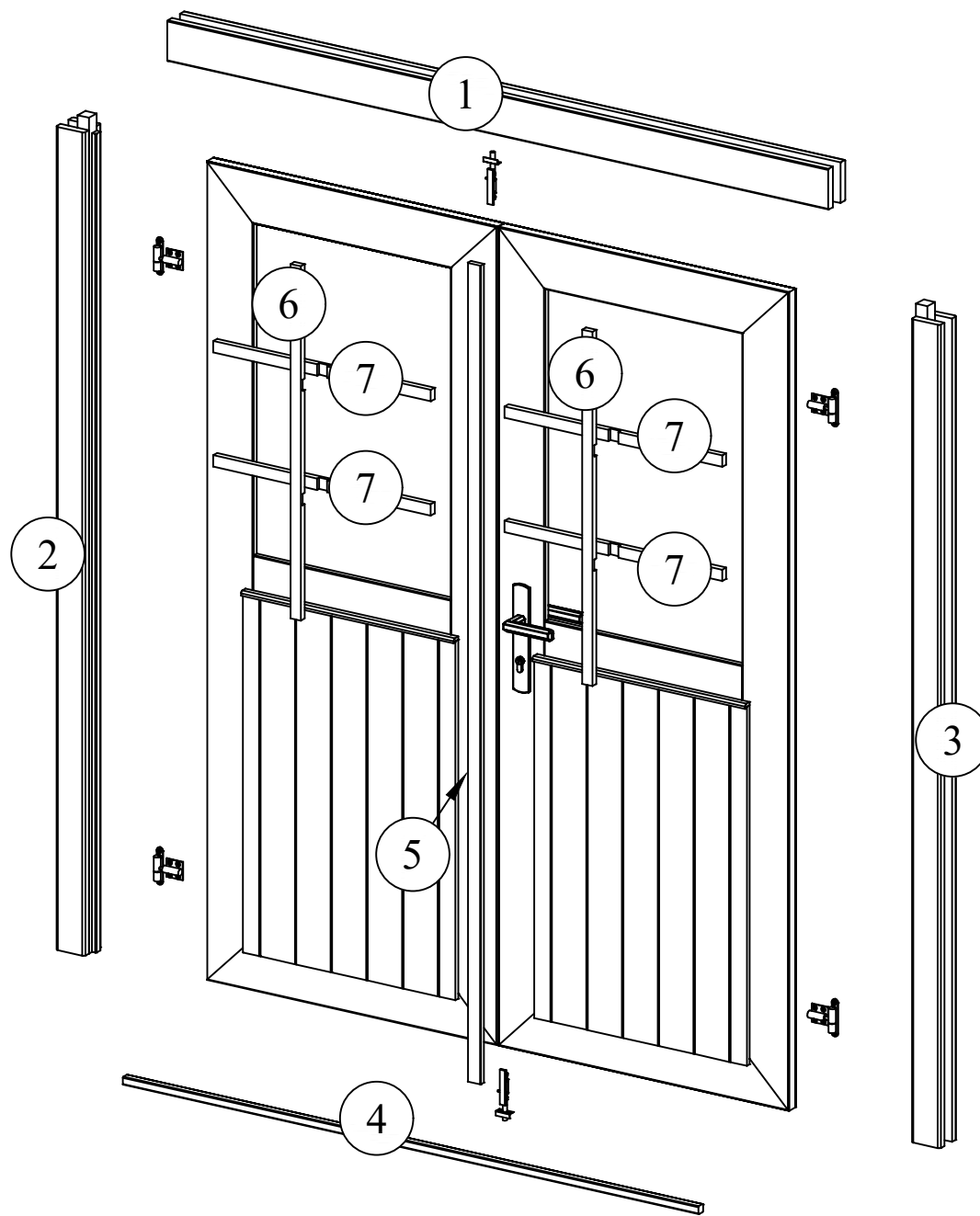

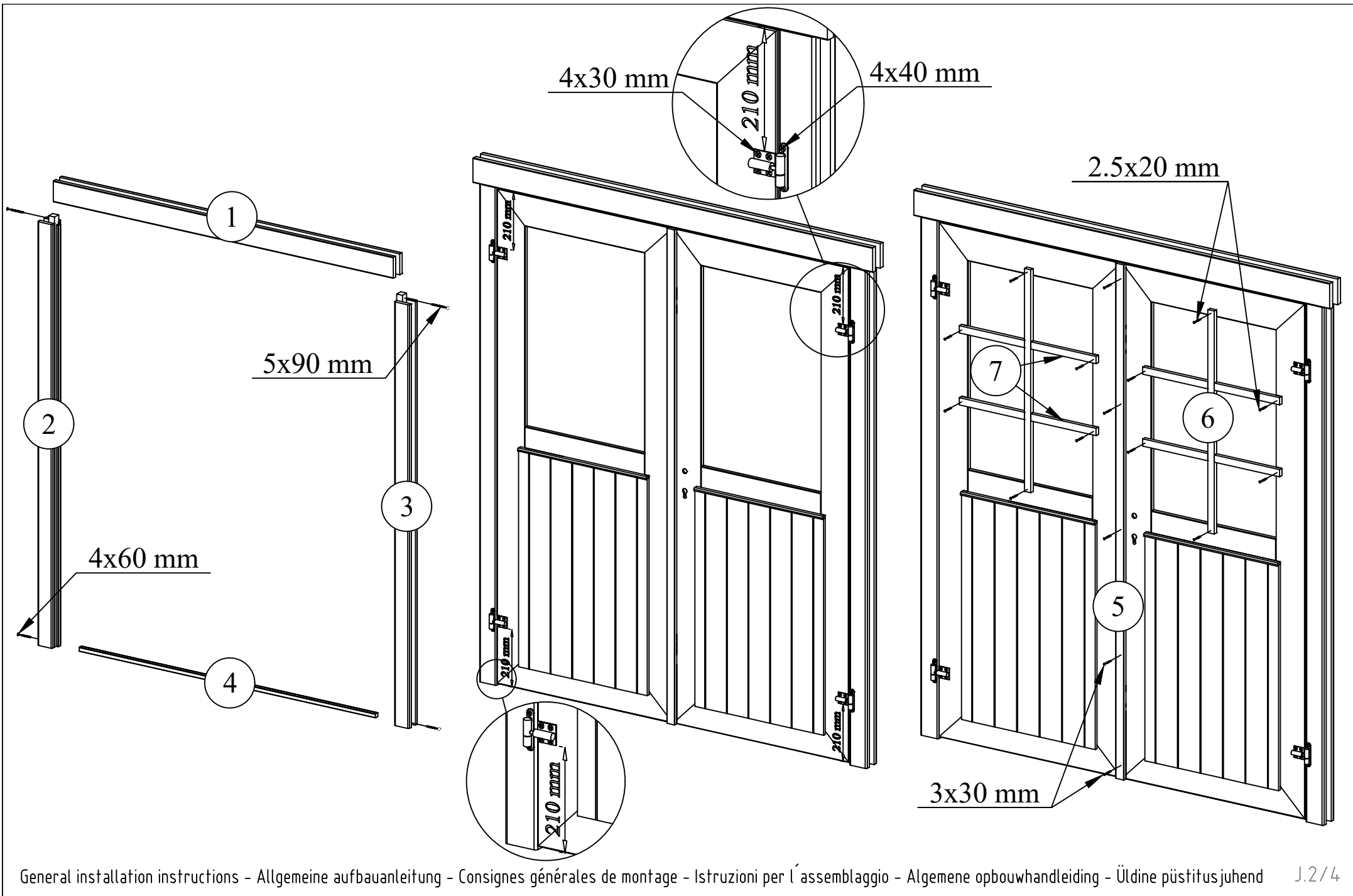

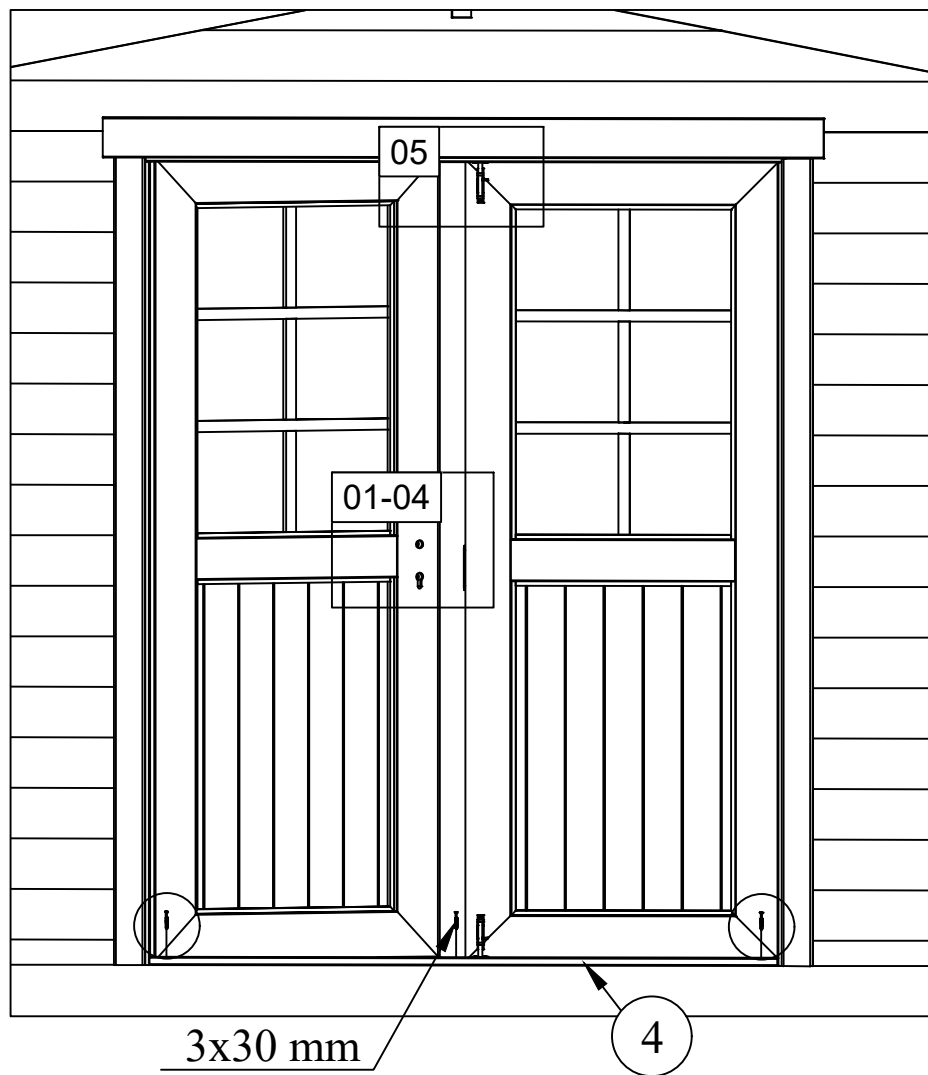

01



04



02



05



03



06

